

LOC		DIST		P		F		ZONE		LTR		REVISIONS			
BD			48									DESCRIPTION	DATE	APPD	
												0	RELEASED PER NPR 2503	1-4-90	-
												A	REV PER EC 0020-117-93	03/17/93	SB
												B	REV PER EC 0020-84-93	06/07/93	SB
												C	REV PER EC 0020-309-95	05/04/95	JS
												D	REV PER EC 0020-881-95	25 AUG 95	JS
												E	REV PER EC 0640-120-98	01 MAY 98	JK

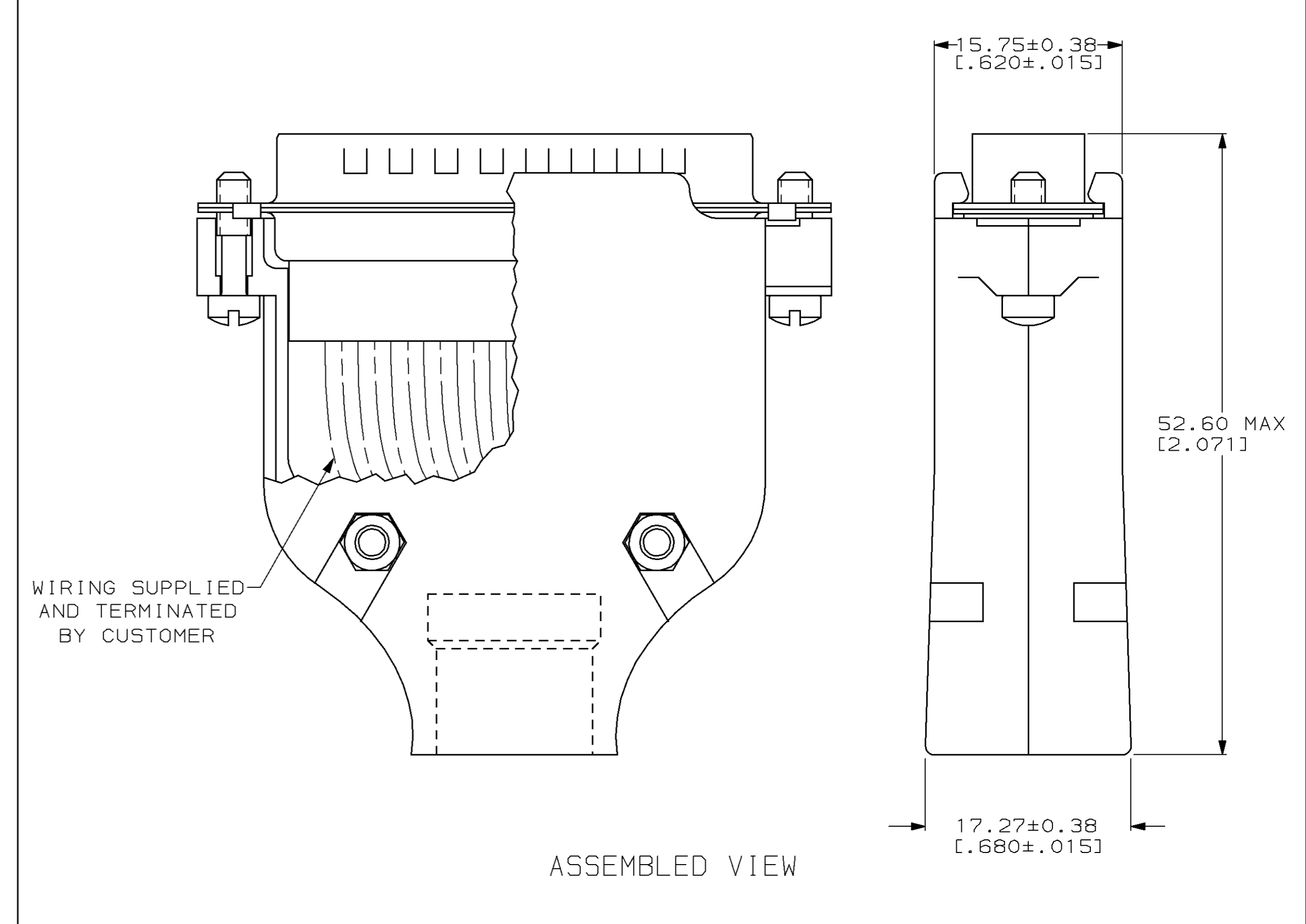

1. CONTACTS ACCEPT 24-20 AWG RANGE.
2. NYLON, GLASS FILLED, UL 94V-0 RATED, BLACK.
3. PVC, UL 94V-0 RATED, BLACK.
4. BRASS.
5. CARBON STEEL.
6. CABLE CLAMPS: ZINC; SCREWS & NUTS: CARBON STEEL.
7. GOLD PLATING PER MIL-G-45204; NICKEL PLATING PER QQ-N-290; TIN PLATING PER MIL-T-10727; COPPER PLATING PER MIL-C-14550; ZINC PLATING PER ASTM B633, TYPE III, CLASS SC1, CLEAR CHROMATE.
8. GOLD FLASH FOR A LENGTH OF 3.81 [0.150] MIN FROM MATING END, 2.54µm [0.000100] MIN TIN OR TIN-LEAD ON OPPOSITE END FOR A LENGTH OF 4.06 [0.160] MIN FROM END OF INSULATION BARREL, BOTH OVER 0.76µm [0.00030] MIN NICKEL ON ENTIRE CONTACT.
9. 5.08µm [0.000200] MIN TIN OVER 1.27µm [0.000050] MIN COPPER.
10. MOUNTING SCREWS & NUTS: 3.81µm [0.000150] MIN ZINC; FILISTER HEAD SCREWS: ZINC.

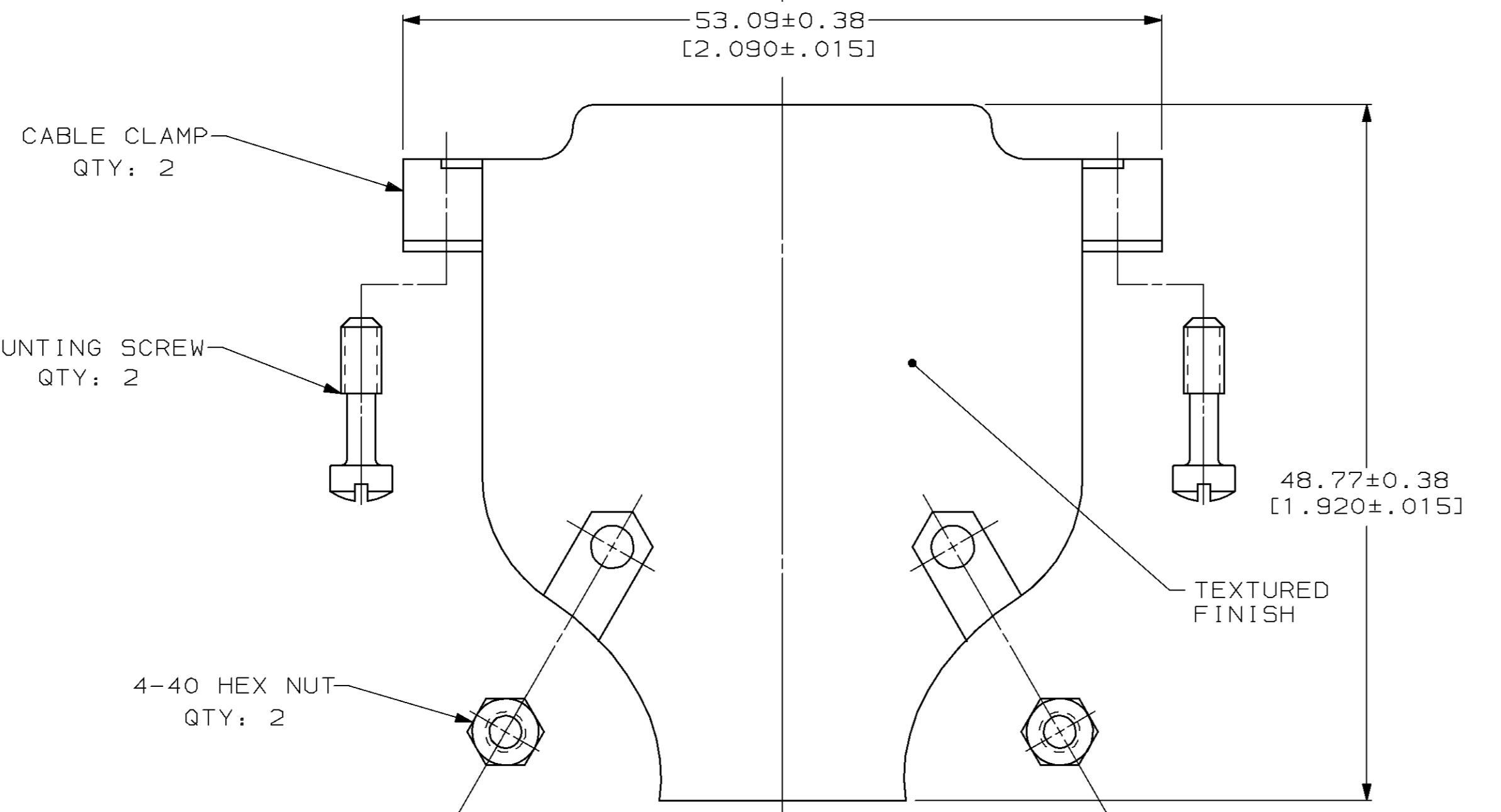
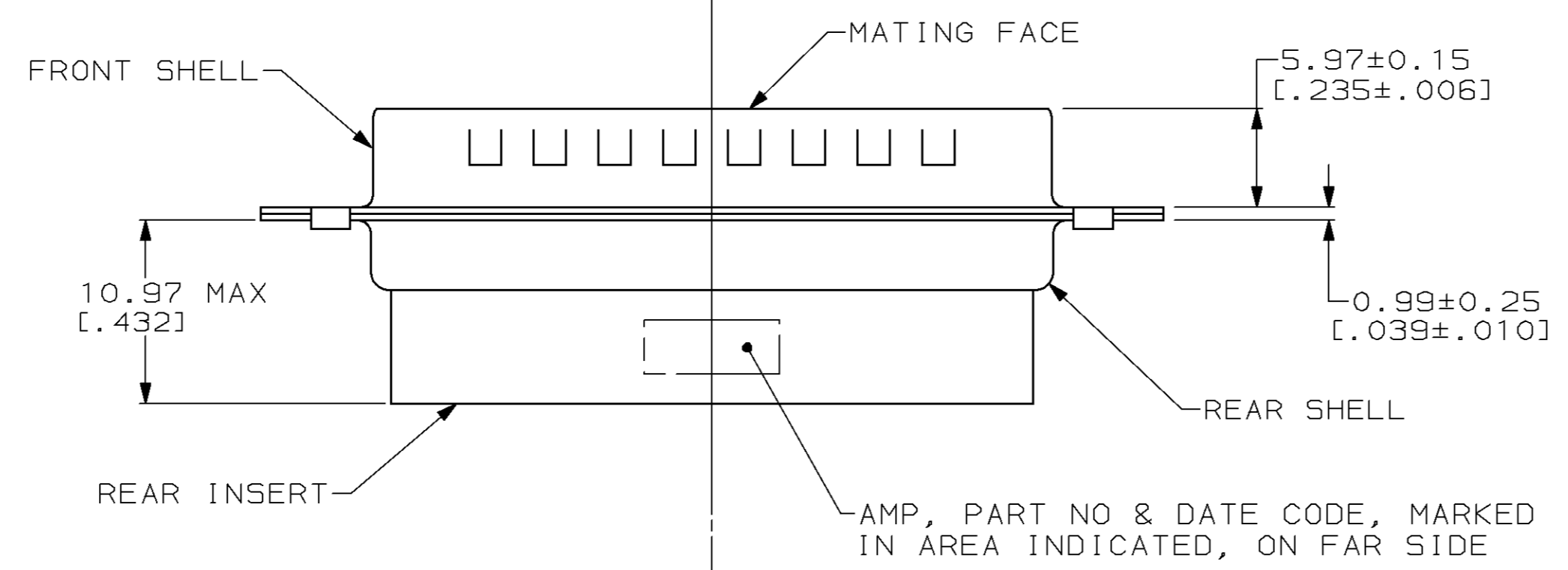
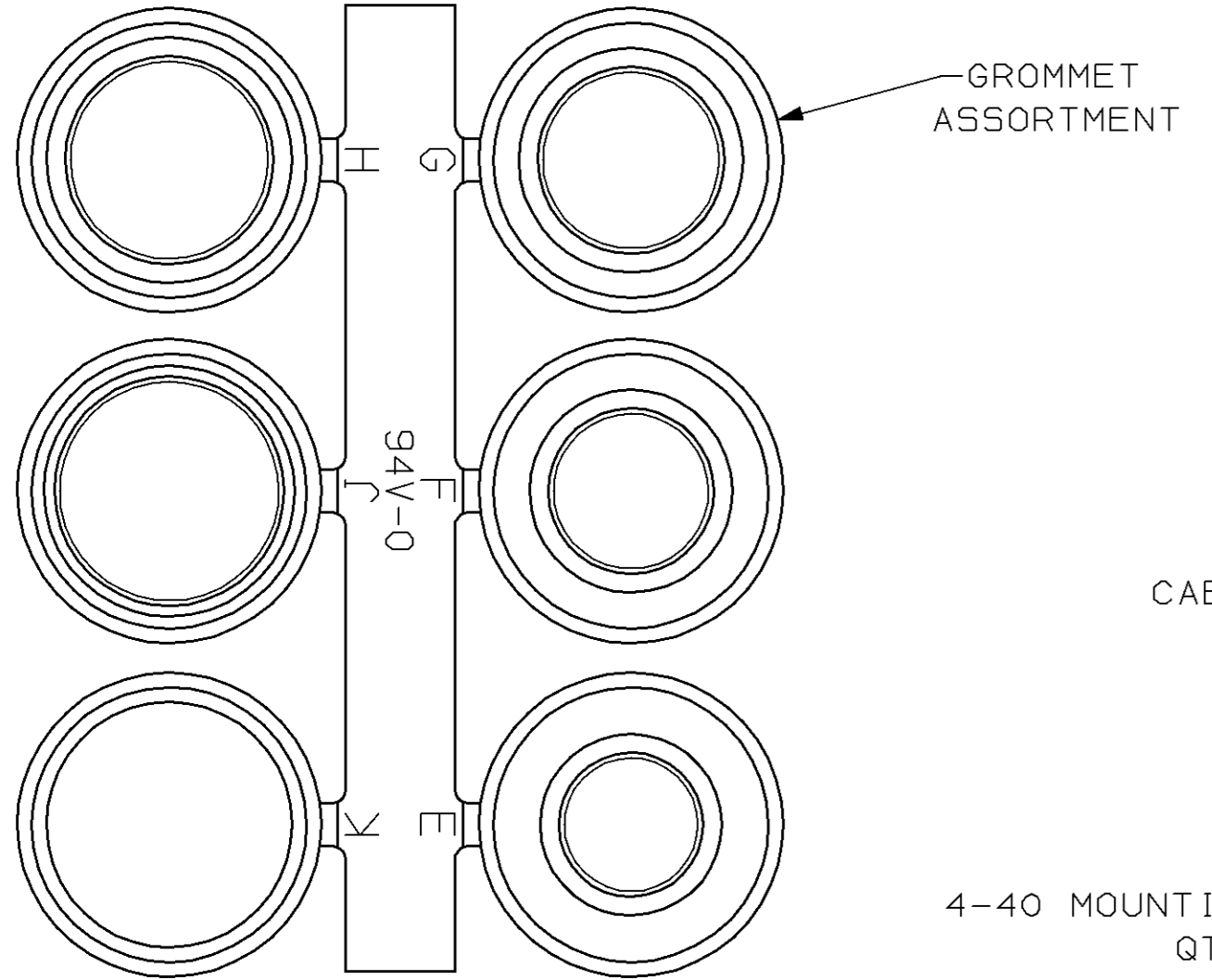
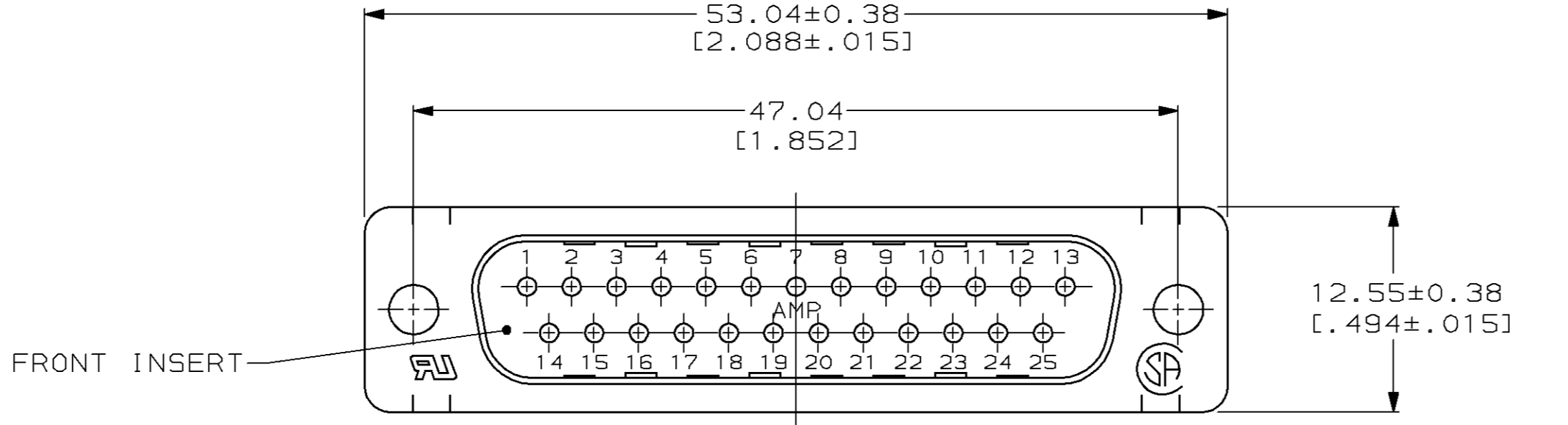
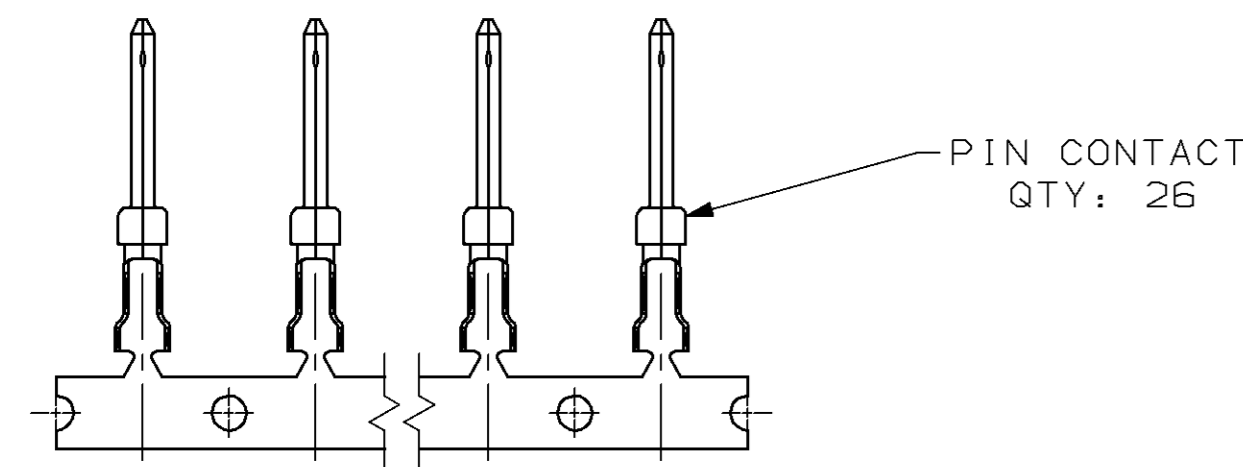
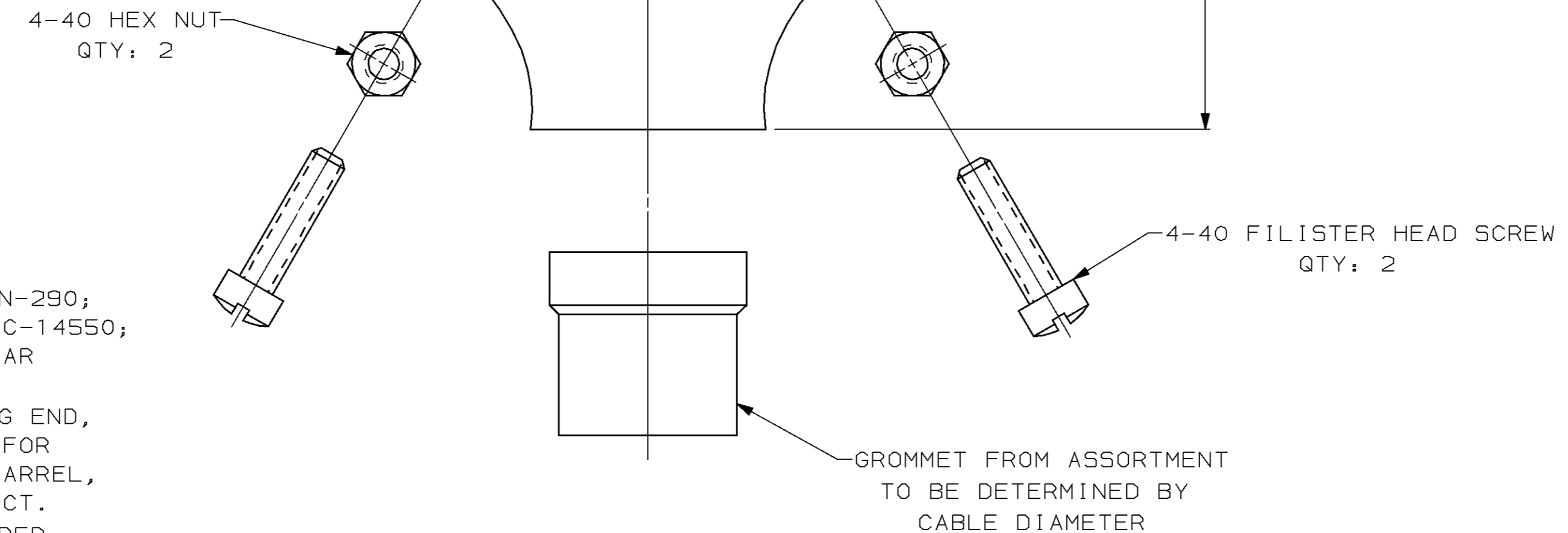

DO NOT SCALE PRINT. UNLESS SPECIFIED DIMENSIONS IN mm [INCHES] TOLERANCES: ON ; 2 PLC DEC ± 0.13 [0.005] 3 PLC DEC ± - ANGLES ± -		DR 1-5-90 W.G.LENKER		749805-3 PART NO	
MATERIAL INSERTS: △ GROMMETS: △ CONTACTS: △ SHELLS: △ HARDWARE: △		CHK 6-4-90 R.STONE		AMP INCORPORATED Harrisburg, Pa. 17105	
FINISH CONTACTS: △ SHELLS: △ HARDWARE: △		APPD 6-5-90 B.TAYLOR		NAME PLUG KIT, UNASSEMBLED, SIZE 3, 25 POSITION, METAL SHELL, AMPLIMITE® HDP-20	
APPD 6-6-90 J.ASSINI		PRODUCT SPEC 108-40011		DRAWING NO 749805-3	
APPLICATION SPEC 114-40003		SCALE 3:1		SHEET 1 OF 1	